



PROTEUS RAYZOR 1960

Photometric Test Report

©2022 **ELATION PROFESSIONAL** all rights reserved. Information, specifications, diagrams, images, and instructions herein are subject to change without notice. ELATION PROFESSIONAL logo and identifying product names and numbers herein are trademarks of ELATION PROFESSIONAL. Copyright protection claimed includes all forms and matters of copyrightable materials and information now allowed by statutory or judicial law or hereinafter granted. Product names used in this document may be trademarks or registered trademarks of their respective companies and are hereby acknowledged. All non-ELATION brands and product names are trademarks or registered trademarks of their respective companies.

Elation Professional USA | 6122 S. Eastern Ave. | Los Angeles, CA. 90040

323-582-3322 | 323-832-9142 fax | www.elationlighting.com | info@elationlighting.com

Elation Professional B.V. | Junostraat 2 | 6468 EW Kerkrade, The Netherlands

+31 45 546 85 66 | +31 45 546 85 96 fax | www.elationlighting.eu | info@elationlighting.eu

Elation Professional Mexico | AV Santa Ana 30 | Parque Industrial Lerma, Lerma, Mexico 52000

+52 (728) 282-7070

CONTENTS

Testing Process	4
Zoom In	5
Zoom 50%	10
Zoom Out	15
High CRI	20

Testing Process

Total Lumen Measurements

Lumens are measured using a Viso Systems Lab Spion. As a goniophotometer, the Viso calculates the field lumens of the fixture by taking multiple measurements across the light beam.

Many lumens figures provided for entertainment lighting fixtures are only 2π sphere values, some even emphasize the LED engine lumens. All Elation product photometric data is the actual light output from the fixture lens, never a theoretical value based on calculation or using the source lumens as the fixtures output. We advise to always compare total fixture lumens acquired with identical measurement systems when comparing lighting fixtures.

Test Lab Equipment and Process

Elation operates an optical testing laboratory at its Los Angeles, CA headquarters to provide accurate photometric data for its lighting products. The testing lab is both light and climate- controlled and contains a variety of precise lighting measurement systems. Fixtures are analyzed with the sophisticated [Viso Systems Lab Spion](#) equipment, which measures all light and color parameters by panning the light beam at a precise speed and from different angles through a calibrated, laser aligned light and color sensor. Test data is collected and summarized by the Viso Light Inspector software. This type of measurement system is referred to as a Goniophotometer.

The Viso software calculates all relevant types of measurements, from beam angles, candela to center light intensity at a variety of distances to the latest color quality measurements like TM30 or CQS as well as accurate color temperature. This wealth of data is then processed by an Elation specific template which is included in the photometric test report for various fixture conditions such as zoom angles and color correction filters.

The Viso software also creates IES (Illuminating Engineering Society) files for each test report. IES is an industry standard file format created for the easy electronic transfer of photometric test data, which is widely used by lighting manufacturers for photometric data distribution.

Additionally, fixtures are periodically rechecked for accuracy using various hand-held light meters including one or more of the devices listed below. This is done to ensure the test data contained in this report is as accurate as possible.

[Asenstek Lighting Passport](#) | [Konica Minolta T-10](#) | [Sekonic C700T](#)

Photometric Report

Total Lumen Output*

VISO Lab Spion 8823 lm

Beam Angle 50%	Field Angle 10%	Cutoff Angle 2.5%
5.6°	7.8°	8.8°

Color Temperature: 0 K

CRI: 0.0

TLCI: n/a

TM30: 0.0

CQS: 0.0

Voltage: 118 V, Current: 11.8 A

Power: 1388 W

Efficacy: 6 Lumen/Watt

Measurement Date: 9/19/2022

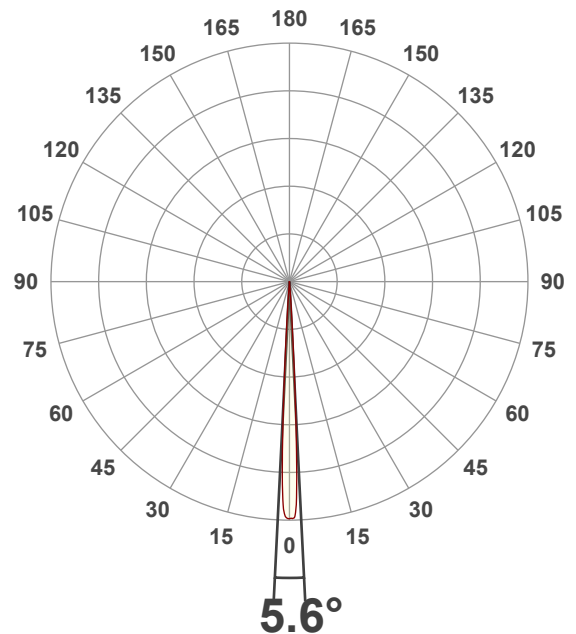

Spectral Distribution

Dominant Wavelength 449 nm

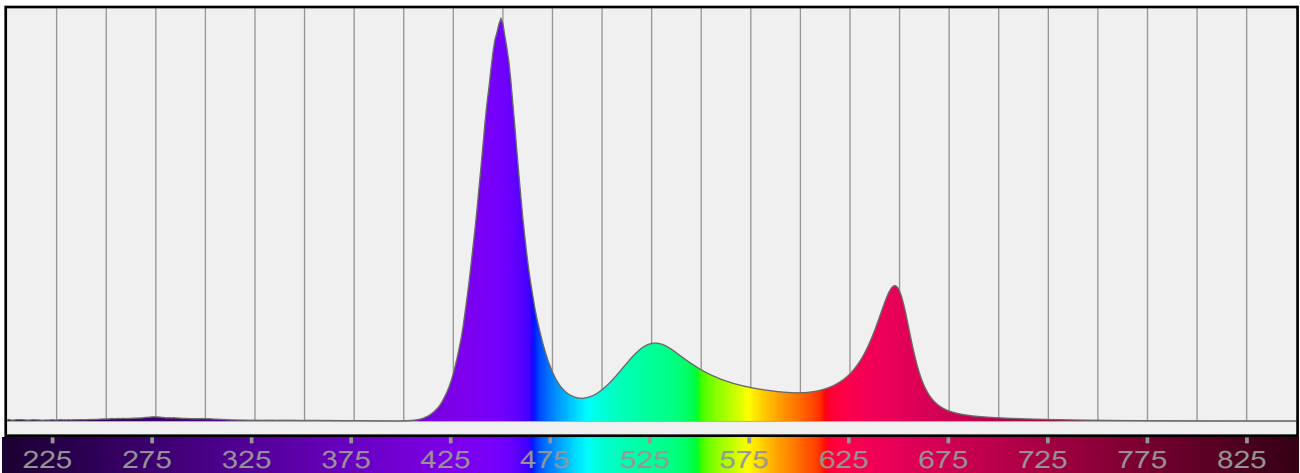

*Total Lumen measurements by calibrated Everfine 2π Integrating Sphere and Viso Systems Lab Spion

Beam Details

Beam Angle 50%	Field Angle 10%	Cutoff Angle 2,5%
5.6°	7.8°	8.8°

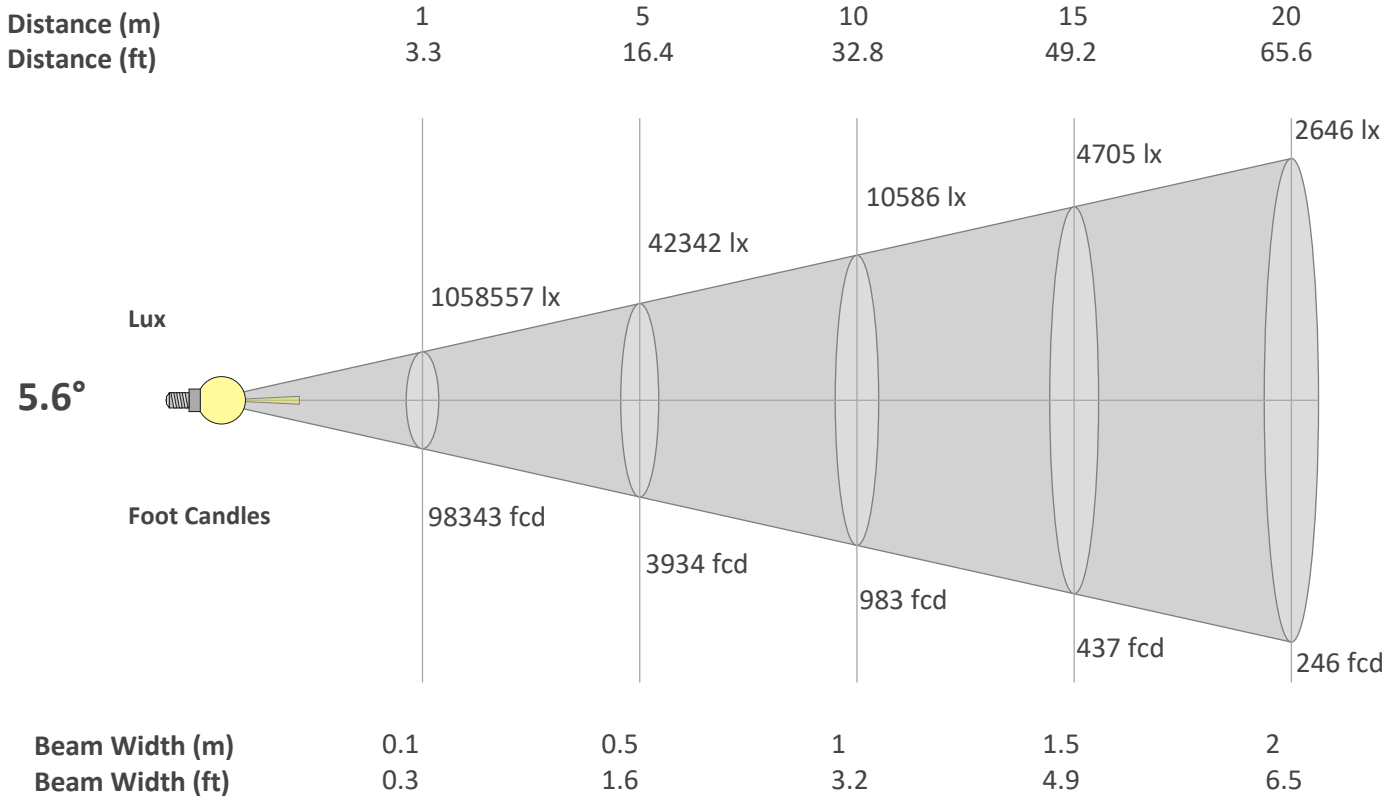

Beam Intensities from 1-20m

M	1	2	3	4	5	6	7	8	9	10	11	12	13	14	15	16	17	18	19	20
FT	3.3	6.6	9.8	13.1	16.4	19.7	23	26.2	29.5	32.8	36.1	39.4	42.7	45.9	49.2	52.5	55.8	59.1	62.3	65.6
LX	1058557	264639	117617	66160	42342	29404	21603	16540	13069	10586	8748	7351	6264	5401	4705	4135	3663	3267	2932	2646
FC	98343.2	24585.8	10927	6146.4	3933.7	2731.8	2007	1536.6	1214.1	983.4	812.8	682.9	581.9	501.8	437.1	384.2	340.3	303.5	272.4	245.9

Linear Distribution

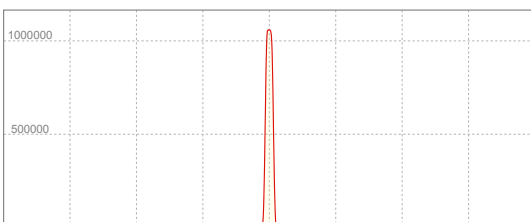

Peak Candela
1058999 cd

Calculate Center Beam Intensities

lux = 1058999 / distance(m)²
fc = 1058999 / distance(ft)²

Color Details

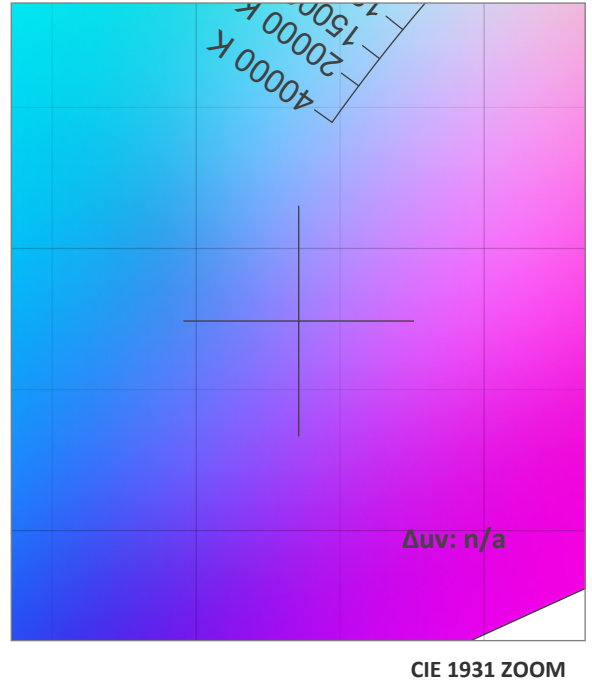
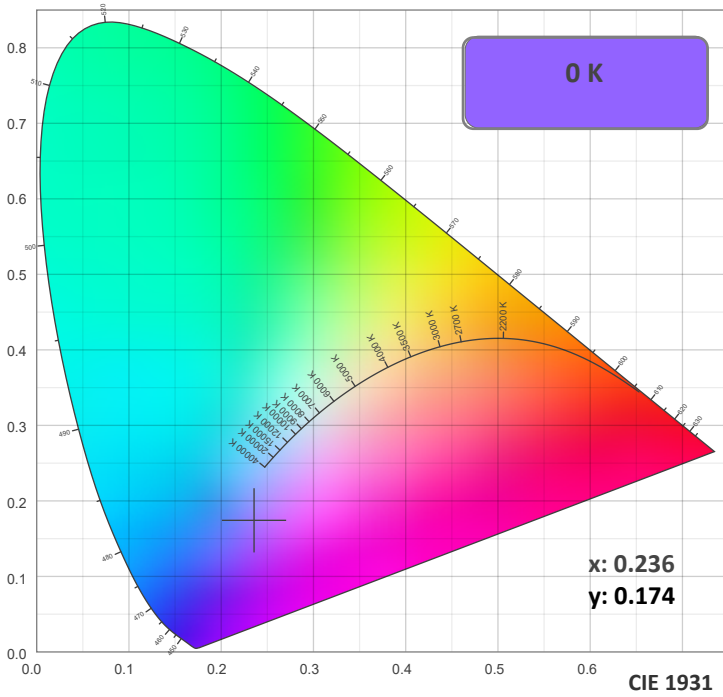

TM30: 0.0

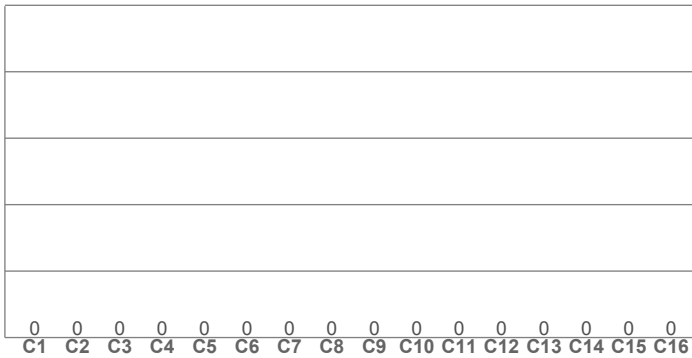

CRI: 0.0 (R1-R8)

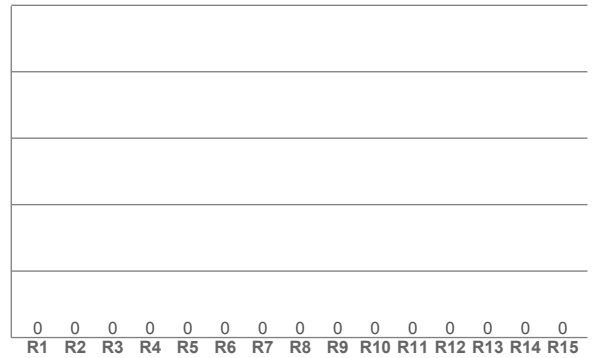

CRI R values, only R1-R8 are used to calculate final CRI value

R1	R2	R3	R4	R5	R6	R7	R8	R9	R10	R11	R12	R13	R14	R15
0.0	0.0	0.0	0.0	0.0	0.0	0.0	0.0	0.0	0.0	0.0	0.0	0.0	0.0	0.0

TM30 C Values, 16 binned values out of total of 99 C values

C1	C2	C3	C4	C5	C6	C7	C8	C9	C10	C11	C12	C13	C14	C15	C16
0.0	0.0	0.0	0.0	0.0	0.0	0.0	0.0	0.0	0.0	0.0	0.0	0.0	0.0	0.0	0.0

CQS Q Values

Q1	Q2	Q3	Q4	Q5	Q6	Q7	Q8	Q9	Q10	Q11	Q12	Q13	Q14	Q15
0.0	0.0	0.0	0.0	0.0	0.0	0.0	0.0	0.0	0.0	0.0	0.0	0.0	0.0	0.0

CQS: 0.0

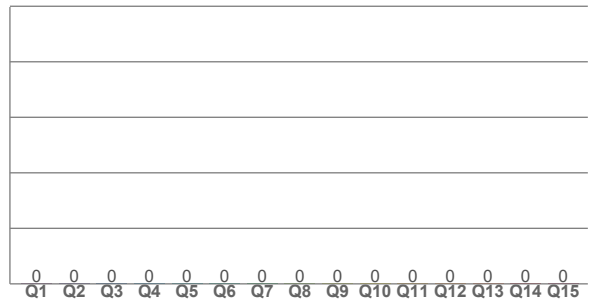

Color Parameters

Color Temperature	Color Rendering Index	Red Component	Color Fidelity	Color Gamut	Color Quality Scale	Color Coordinate CIE 1931	Color Coordinate CIE 1931	Color Coordinate	Color Coordinate	Color Deviation from Black
CCT	CRI	CRI R9	TM30 Rf	TM30 Rg	CQS	x	y	u	v	Δuv
0 K	0.0	0.0	0.0	0.0	0.0	0.236	0.174	0.204	0.226	n/a

TM30 Details

Rf 0.0
Fidelity Index Rf

Rg 0.0
Gamut Index Rg

Hue Bin	R _f	Graphic shifts (%)	
		Chroma	Hue
1	0	0%	0%
2	0	0%	0%
3	0	0%	0%
4	0	0%	0%
5	0	0%	0%
6	0	0%	0%
7	0	0%	0%
8	0	0%	0%
9	0	0%	0%
10	0	0%	0%
11	0	0%	0%
12	0	0%	0%
13	0	0%	0%
14	0	0%	0%
15	0	0%	0%
16	0	0%	0%

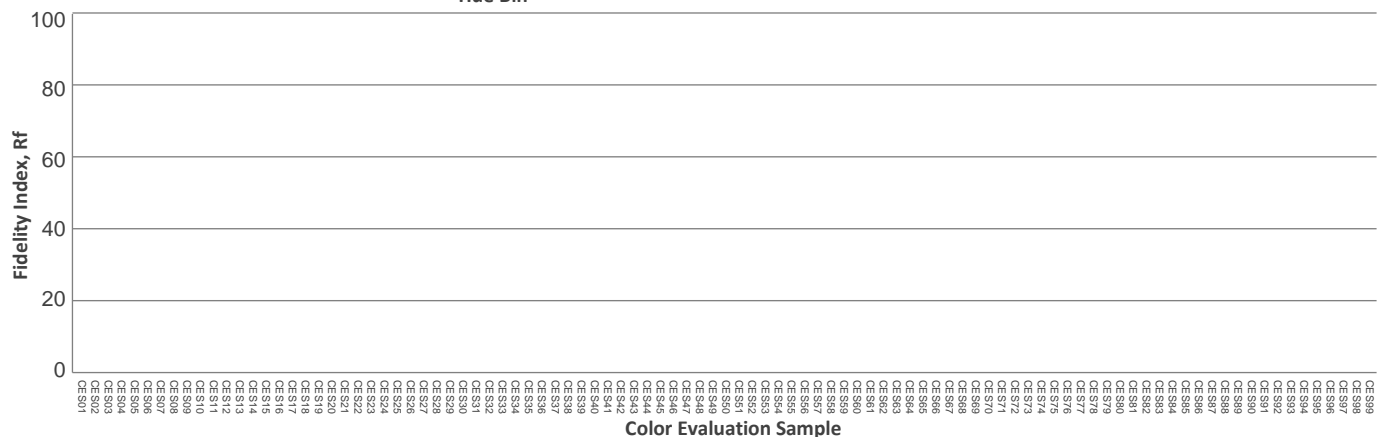
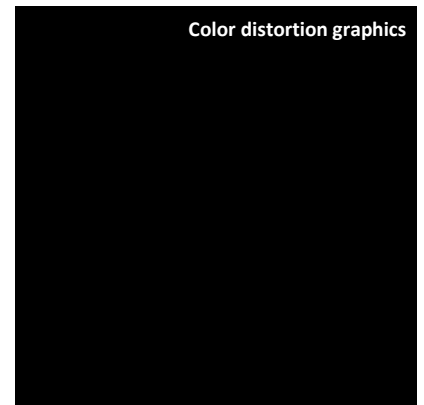
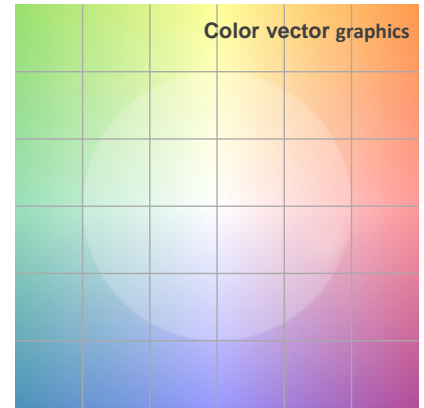
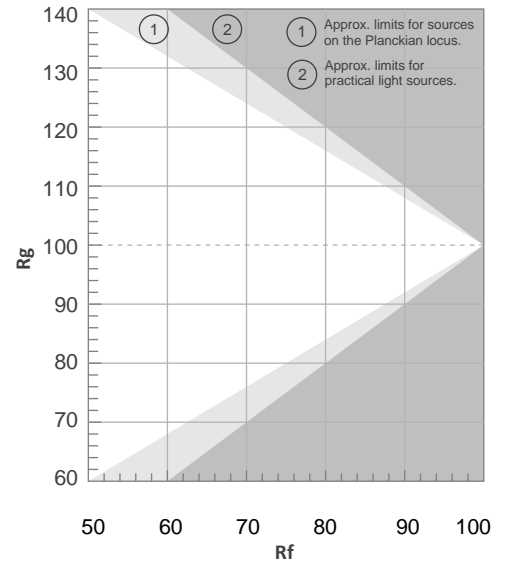

ISO Diagrams

ISO Candela Diagram

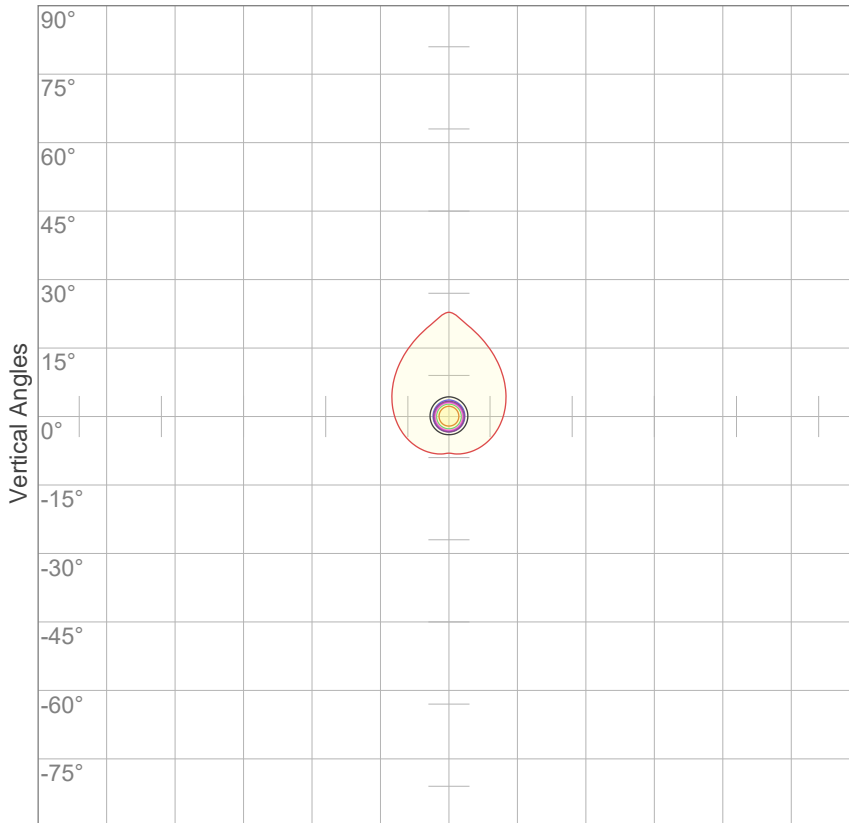

10%	105856 cd
20%	211711 cd
30%	317567 cd
40%	423423 cd
50%	529278 cd
60%	635134 cd
70%	740990 cd
80%	846845 cd
90%	952701 cd

Conditions:
 Number of c-planes: 2
 Candela at center: 1058557 cd

Horizontal Angles

ISO Lux Diagram

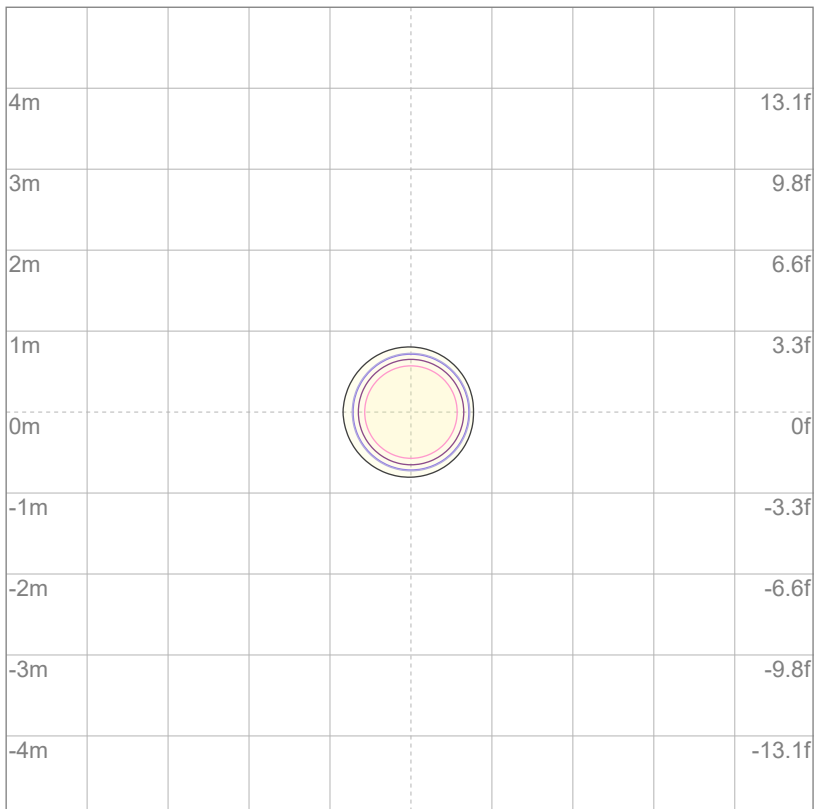

3%	318 lx
5%	529 lx
10%	1059 lx
30%	3176 lx
50%	5293 lx

Conditions:
 Number of c-planes: 2
 Lux at center: 10.6K lx

Lux distribution on a surface when lamp is mounted at 10 meters from the surface.

Mounting Height: 10 meters (33 feet)

Photometric Report

Total Lumen Output*

VISO Lab Spion 15112 lm

Beam Angle 50%	Field Angle 10%	Cutoff Angle 2.5%
26.7°	32°	34.3°

Color Temperature: 0 K

CRI: 0.0

TLCI: n/a

TM30: 0.0

CQS: 0.0

Voltage: 116 V, Current: 11.9 A

Power: 1388 W

Efficacy: 11 Lumen/Watt

Measurement Date: 9/20/2022

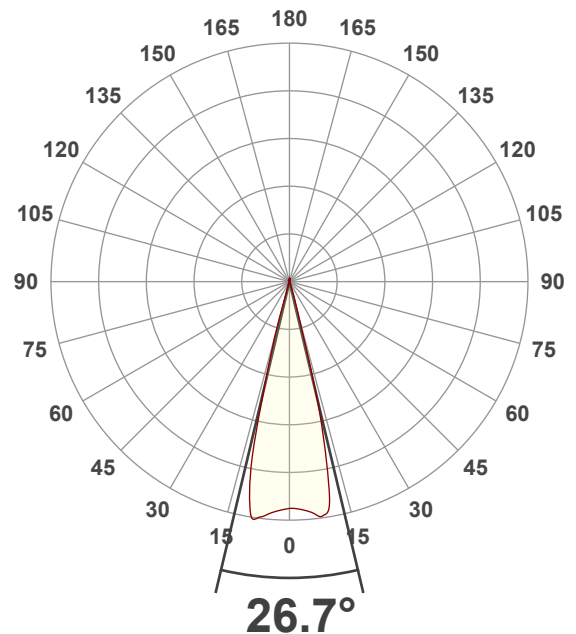

Spectral Distribution

Dominant Wavelength 450 nm

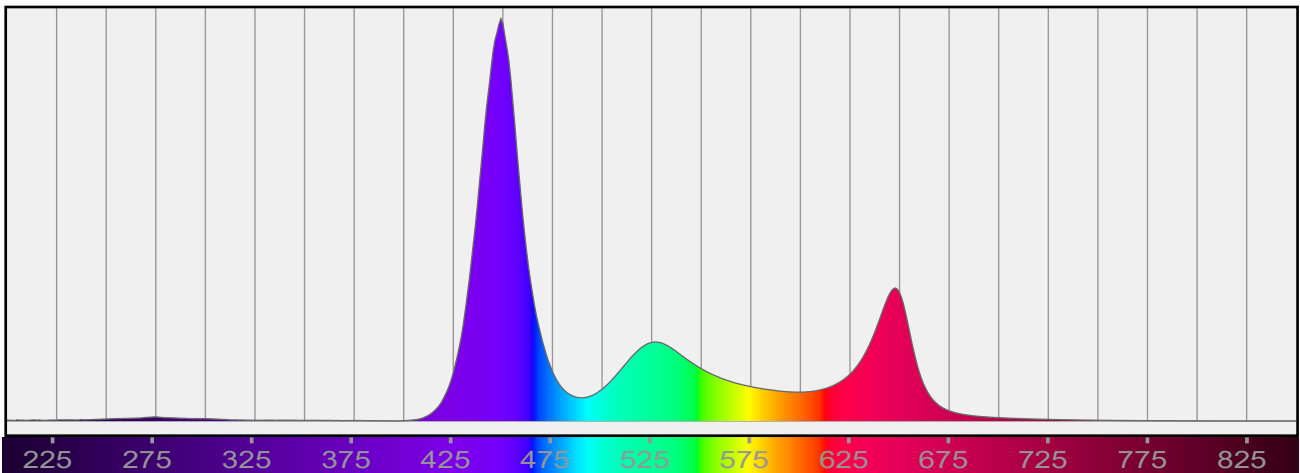

*Total Lumen measurements by calibrated Everfine 2π Integrating Sphere and Viso Systems Lab Spion

Beam Details

Beam Angle 50%	Field Angle 10%	Cutoff Angle 2,5%
26.7°	32°	34.3°

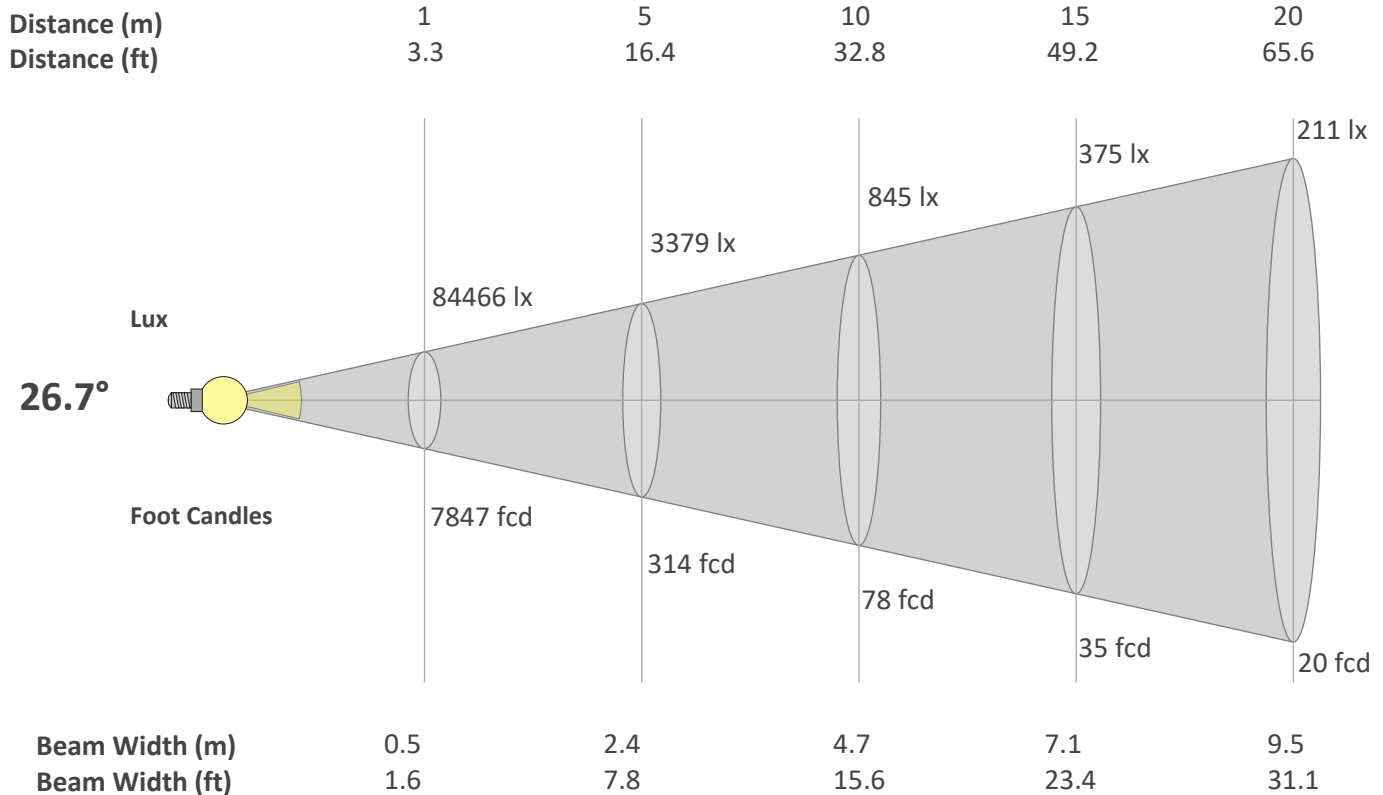

Beam Intensities from 1-20m

M	1	2	3	4	5	6	7	8	9	10	11	12	13	14	15	16	17	18	19	20
FT	3.3	6.6	9.8	13.1	16.4	19.7	23	26.2	29.5	32.8	36.1	39.4	42.7	45.9	49.2	52.5	55.8	59.1	62.3	65.6
LX	84466	21116	9385	5279	3379	2346	1724	1320	1043	845	698	587	500	431	375	330	292	261	234	211
FC	7847.1	1961.8	871.9	490.4	313.9	218	160.1	122.6	96.9	78.5	64.9	54.5	46.4	40	34.9	30.7	27.2	24.2	21.7	19.6

Linear Distribution

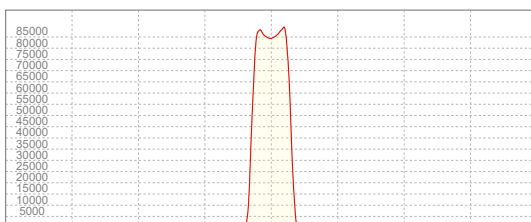

Peak Candela

88178 cd

Calculate Center Beam Intensities

$lux = 88178 / distance(m)^2$

$fc = 88178 / distance(ft)^2$

Color Details

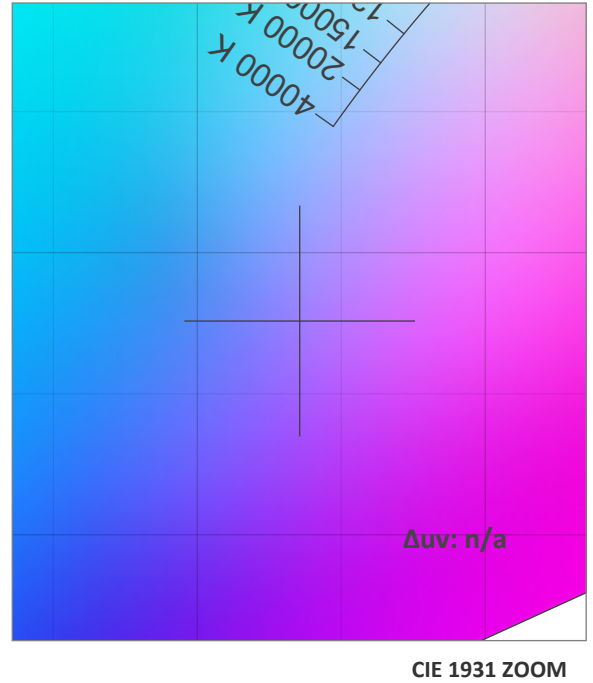
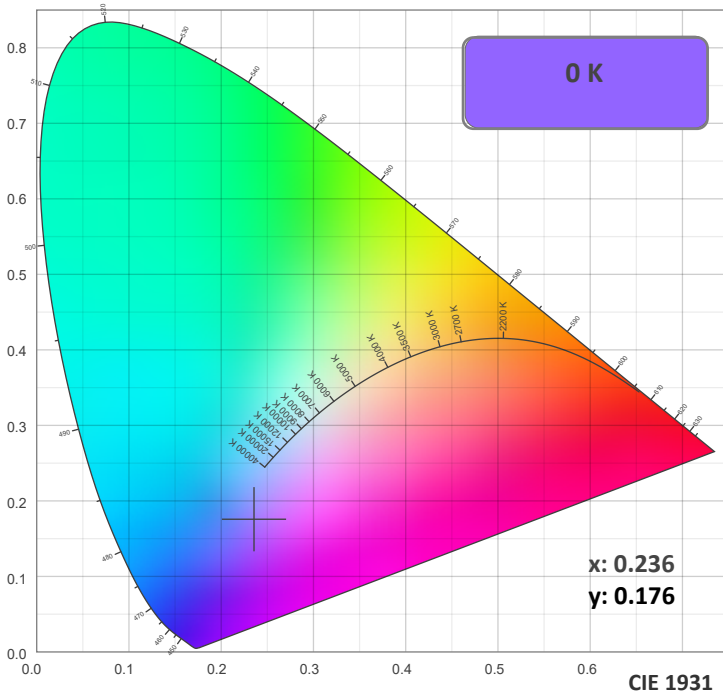

TM30: 0.0

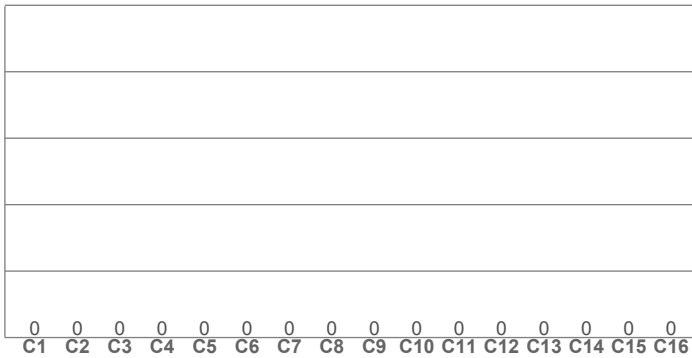

CRI: 0.0 (R1-R8)

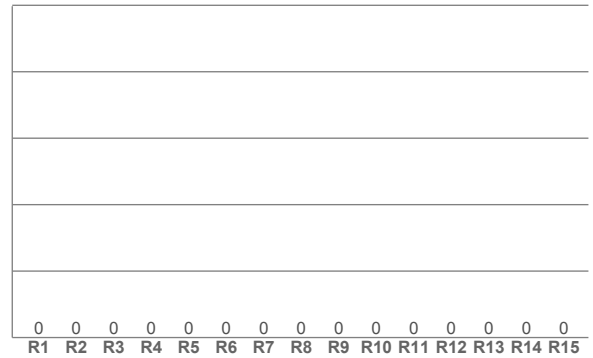

CRI R values, only R1-R8 are used to calculate final CRI value

R1	R2	R3	R4	R5	R6	R7	R8	R9	R10	R11	R12	R13	R14	R15
0.0	0.0	0.0	0.0	0.0	0.0	0.0	0.0	0.0	0.0	0.0	0.0	0.0	0.0	0.0

TM30 C Values, 16 binned values out of total of 99 C values

C1	C2	C3	C4	C5	C6	C7	C8	C9	C10	C11	C12	C13	C14	C15	C16
0.0	0.0	0.0	0.0	0.0	0.0	0.0	0.0	0.0	0.0	0.0	0.0	0.0	0.0	0.0	0.0

CQS Q Values

Q1	Q2	Q3	Q4	Q5	Q6	Q7	Q8	Q9	Q10	Q11	Q12	Q13	Q14	Q15
0.0	0.0	0.0	0.0	0.0	0.0	0.0	0.0	0.0	0.0	0.0	0.0	0.0	0.0	0.0

CQS: 0.0

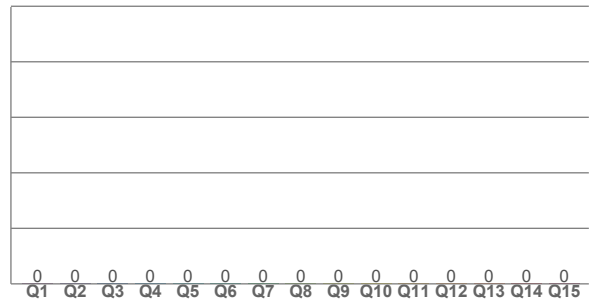

Color Parameters

Color Temperature	Color Rendering Index	Red Component	Color Fidelity	Color Gamut	Color Quality Scale	Color Coordinate CIE 1931	Color Coordinate CIE 1931	Color Coordinate	Color Coordinate	Color Deviation from Black
CCT	CRI	CRI R9	TM30 Rf	TM30 Rg	CQS	x	y	u	v	Δuv
0 K	0.0	0.0	0.0	0.0	0.0	0.236	0.176	0.203	0.227	n/a

TM30 Details

Rf 0.0
Fidelity Index Rf

Rg 0.0
Gamut Index Rg

Hue Bin	Rr	Graphic shifts (%)	
		Chroma	Hue
1	0	0%	0%
2	0	0%	0%
3	0	0%	0%
4	0	0%	0%
5	0	0%	0%
6	0	0%	0%
7	0	0%	0%
8	0	0%	0%
9	0	0%	0%
10	0	0%	0%
11	0	0%	0%
12	0	0%	0%
13	0	0%	0%
14	0	0%	0%
15	0	0%	0%
16	0	0%	0%

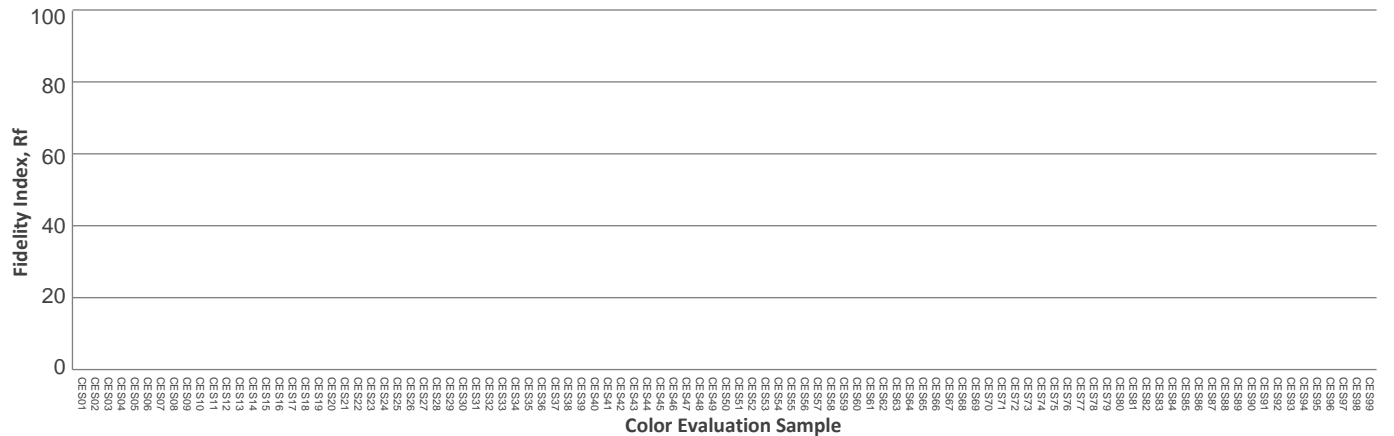
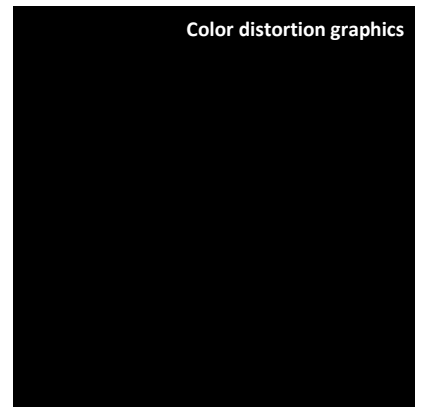
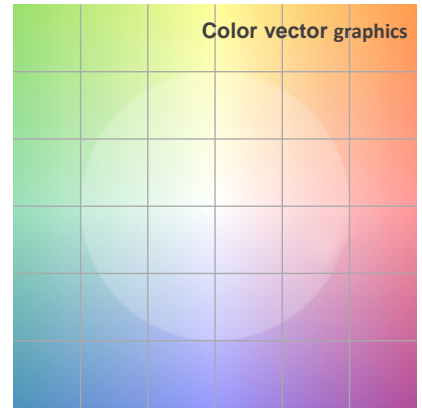
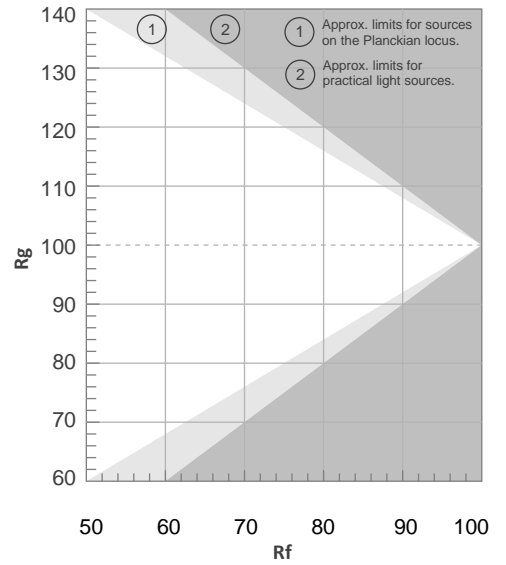

ISO Diagrams

ISO Candela Diagram

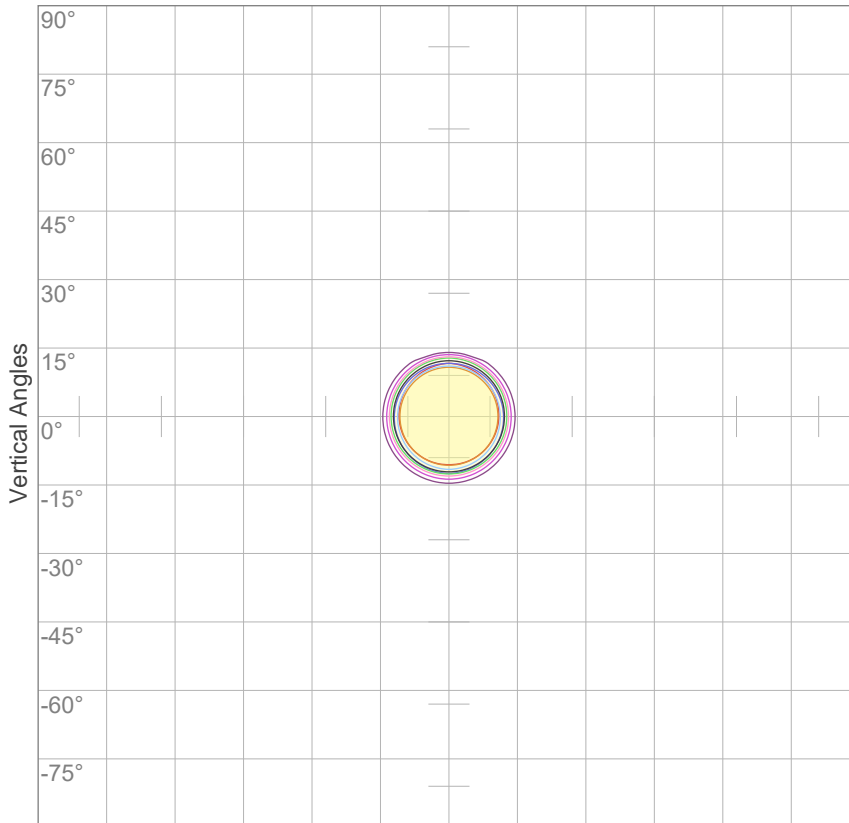

10%	8447 cd
20%	16893 cd
30%	25340 cd
40%	33786 cd
50%	42233 cd
60%	50680 cd
70%	59126 cd
80%	67573 cd
90%	76019 cd

Conditions:
 Number of c-planes: 2
 Candela at center: 84466 cd

ISO Lux Diagram

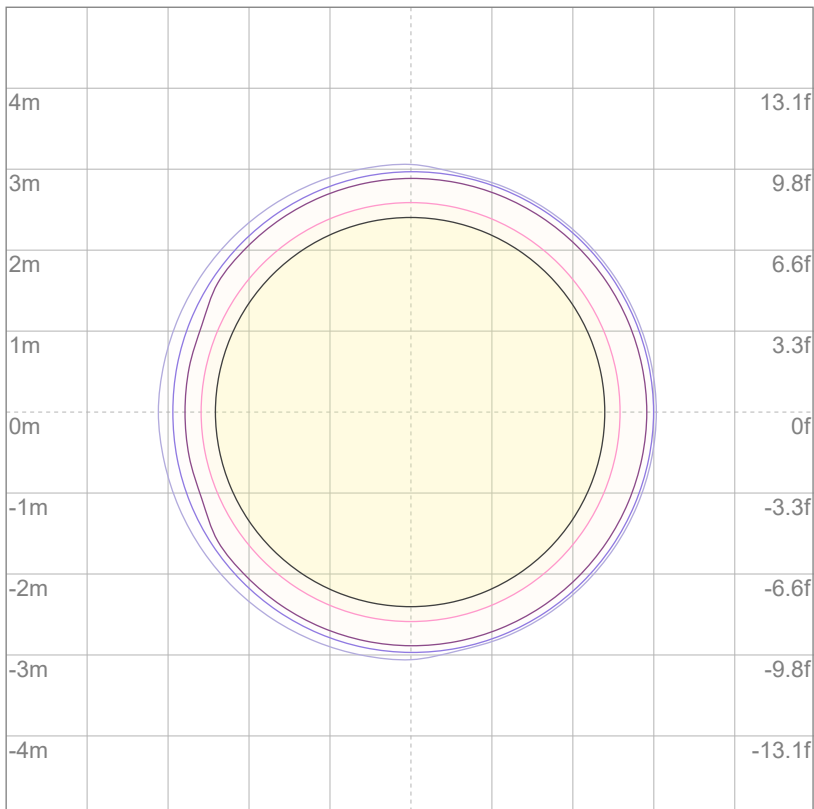

3%	25.3 lx
5%	42.2 lx
10%	84.5 lx
30%	253 lx
50%	422 lx

Conditions:
 Number of c-planes: 2
 Lux at center: 845 lx

Lux distribution on a surface when lamp is mounted at 10 meters from the surface.

Mounting Height: 10 meters (33 feet)

Photometric Report

Total Lumen Output*

VISO Lab Spion 18129 lm

Beam Angle 50%	Field Angle 10%	Cutoff Angle 2.5%
53.6°	71°	76.8°

Color Temperature: 0 K

CRI: 0.0

TLCI: n/a

TM30: 0.0

CQS: 0.0

Voltage: 116 V, Current: 12.0 A

Power: 1388 W

Efficacy: 13 Lumen/Watt

Measurement Date: 9/20/2022

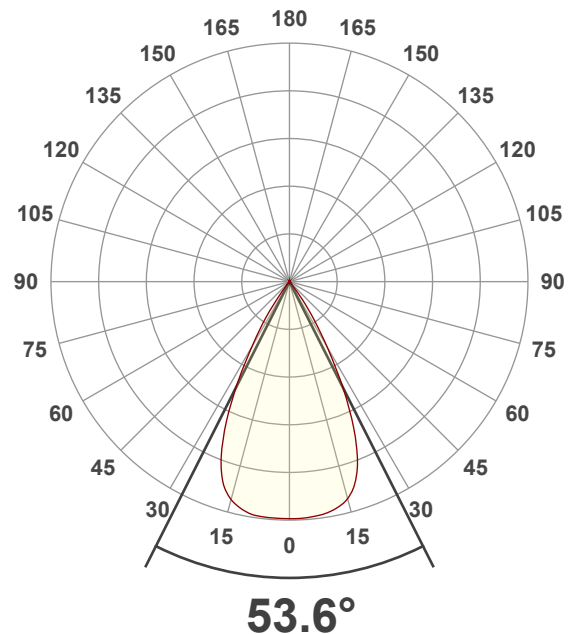

Spectral Distribution

Dominant Wavelength 450 nm

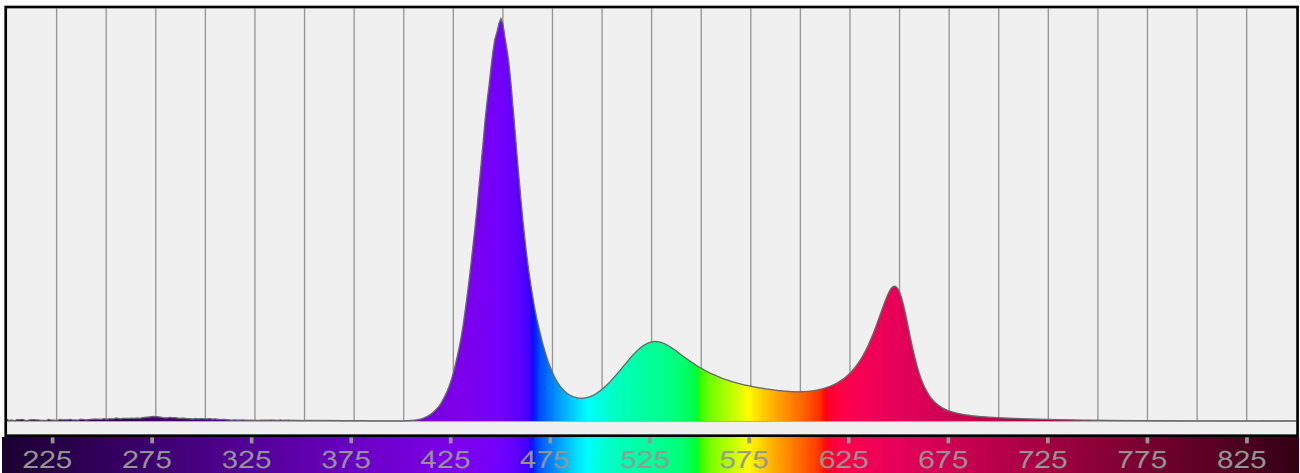

*Total Lumen measurements by calibrated Everfine 2π Integrating Sphere and Viso Systems Lab Spion

Beam Details

Beam Angle 50%	Field Angle 10%	Cutoff Angle 2,5%
53.6°	71°	76.8°

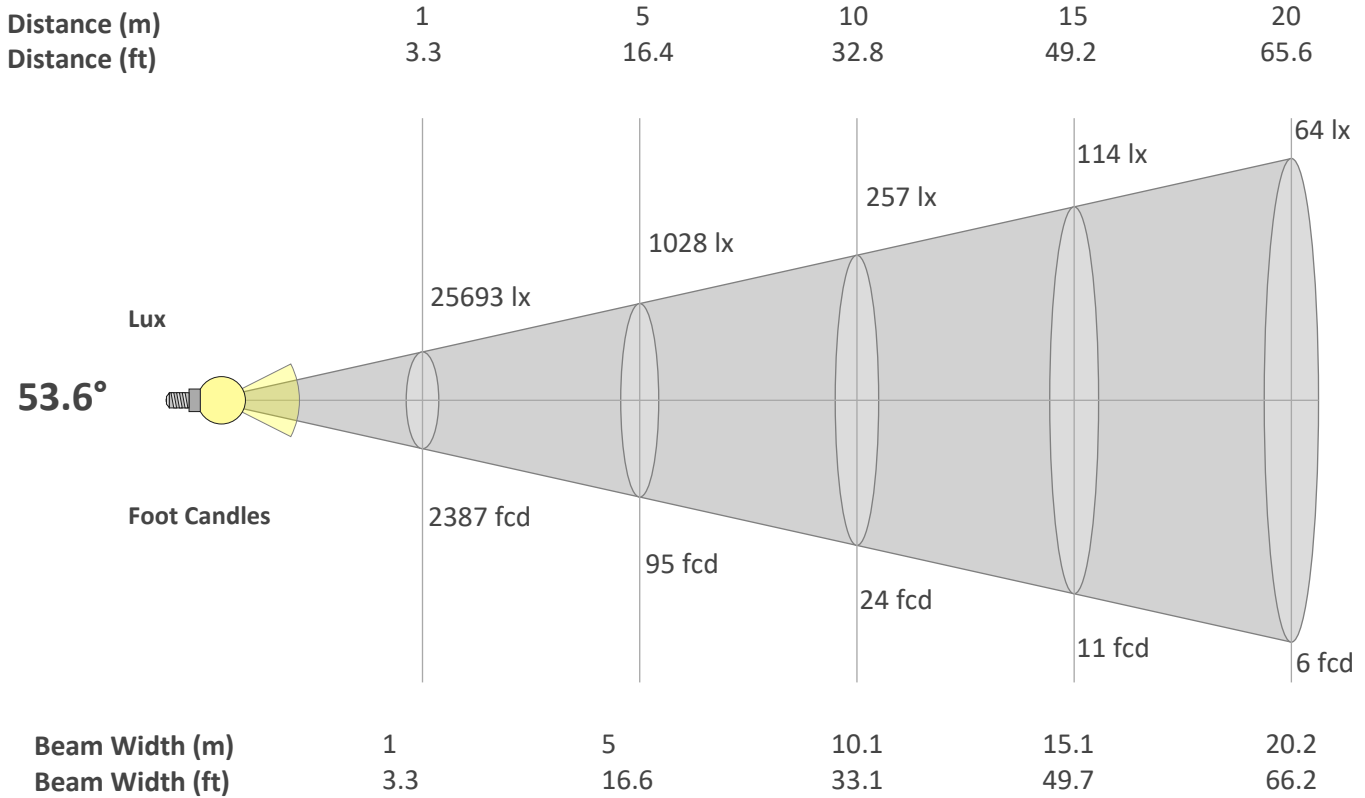

Beam Intensities from 1-20m

M	1	2	3	4	5	6	7	8	9	10	11	12	13	14	15	16	17	18	19	20
FT	3.3	6.6	9.8	13.1	16.4	19.7	23	26.2	29.5	32.8	36.1	39.4	42.7	45.9	49.2	52.5	55.8	59.1	62.3	65.6
LX	25693	6423	2855	1606	1028	714	524	401	317	257	212	178	152	131	114	100	89	79	71	64
FC	2386.9	596.7	265.2	149.2	95.5	66.3	48.7	37.3	29.5	23.9	19.7	16.6	14.1	12.2	10.6	9.3	8.3	7.4	6.6	6

Linear Distribution

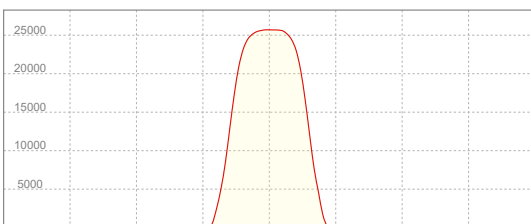

Peak Candela
25695 cd

Calculate Center Beam Intensities

$lux = 25695 / distance(m)^2$

$fc = 25695 / distance(ft)^2$

Color Details

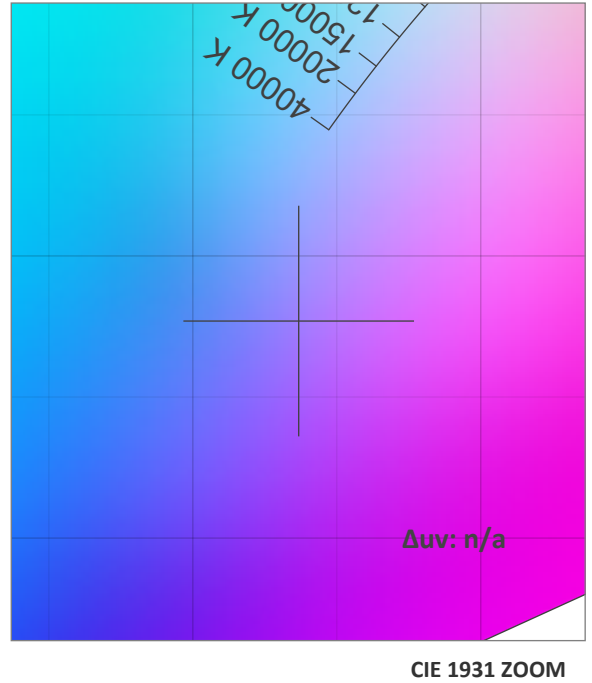
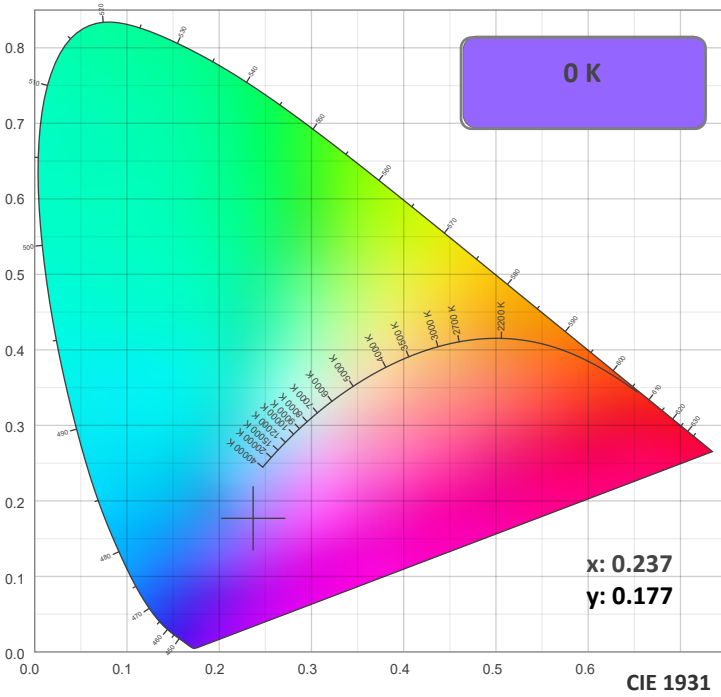

TM30: 0.0

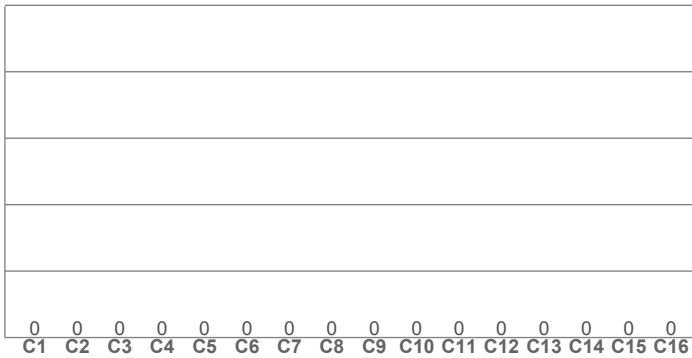

CRI: 0.0 (R1-R8)

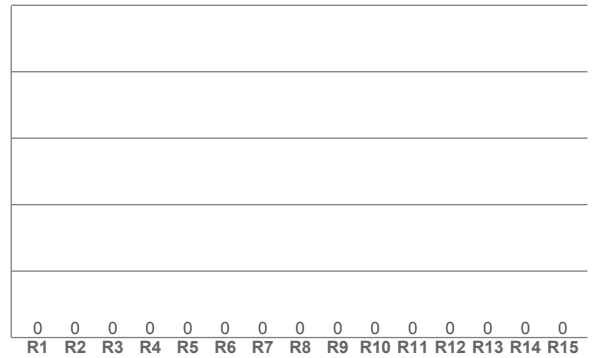

CRI R values, only R1-R8 are used to calculate final CRI value

R1	R2	R3	R4	R5	R6	R7	R8	R9	R10	R11	R12	R13	R14	R15
0.0	0.0	0.0	0.0	0.0	0.0	0.0	0.0	0.0	0.0	0.0	0.0	0.0	0.0	0.0

TM30 C Values, 16 binned values out of total of 99 C values

C1	C2	C3	C4	C5	C6	C7	C8	C9	C10	C11	C12	C13	C14	C15	C16
0.0	0.0	0.0	0.0	0.0	0.0	0.0	0.0	0.0	0.0	0.0	0.0	0.0	0.0	0.0	0.0

CQS Q Values

Q1	Q2	Q3	Q4	Q5	Q6	Q7	Q8	Q9	Q10	Q11	Q12	Q13	Q14	Q15
0.0	0.0	0.0	0.0	0.0	0.0	0.0	0.0	0.0	0.0	0.0	0.0	0.0	0.0	0.0

CQS: 0.0

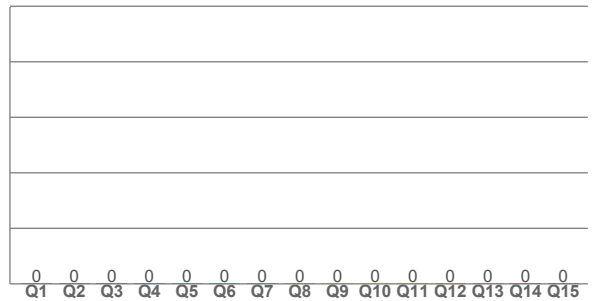

Color Parameters

Color Temperature	Color Rendering Index	Red Component	Color Fidelity	Color Gamut	Color Quality Scale	Color Coordinate CIE 1931	Color Coordinate CIE 1931	Color Coordinate	Color Coordinate	Color Deviation from Black
CCT	CRI	CRI R9	TM30 Rf	TM30 Rg	CQS	x	y	u	v	Δuv
0 K	0.0	0.0	0.0	0.0	0.0	0.237	0.177	0.204	0.228	n/a

TM30 Details

Rf 0.0
Fidelity Index Rf

Rg 0.0
Gamut Index Rg

Hue Bin	R _f	Graphic shifts (%)	
		Chroma	Hue
1	0	0%	0%
2	0	0%	0%
3	0	0%	0%
4	0	0%	0%
5	0	0%	0%
6	0	0%	0%
7	0	0%	0%
8	0	0%	0%
9	0	0%	0%
10	0	0%	0%
11	0	0%	0%
12	0	0%	0%
13	0	0%	0%
14	0	0%	0%
15	0	0%	0%
16	0	0%	0%

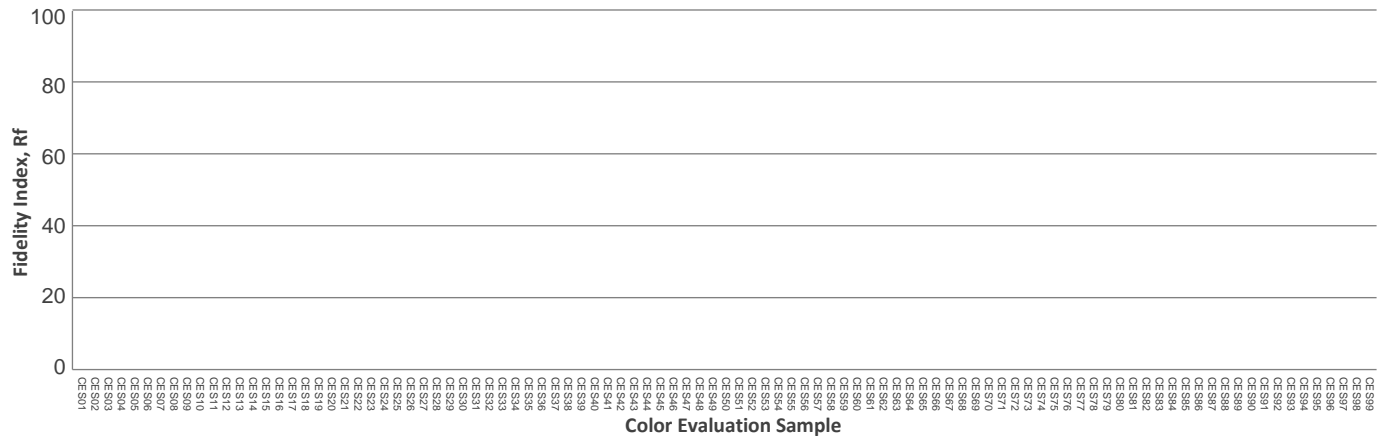
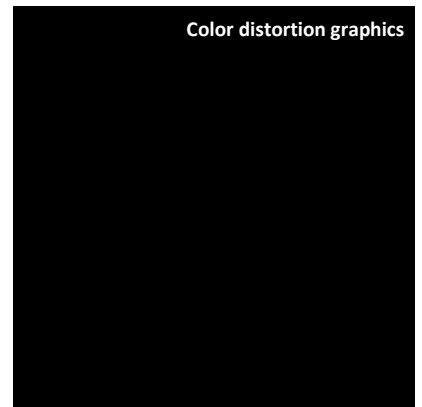
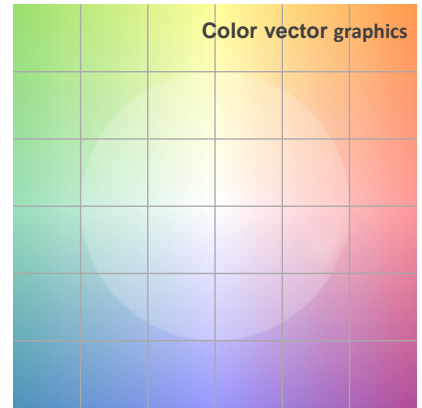
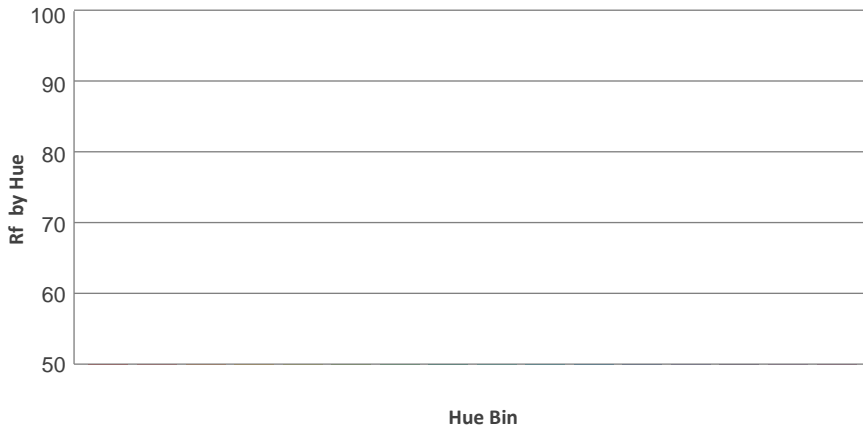
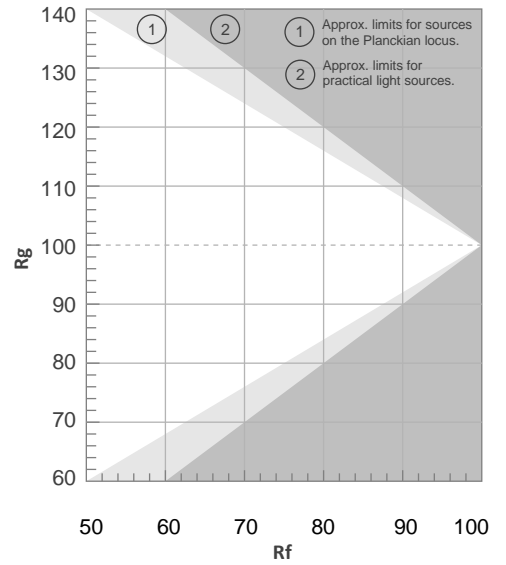

ISO Diagrams

ISO Candela Diagram

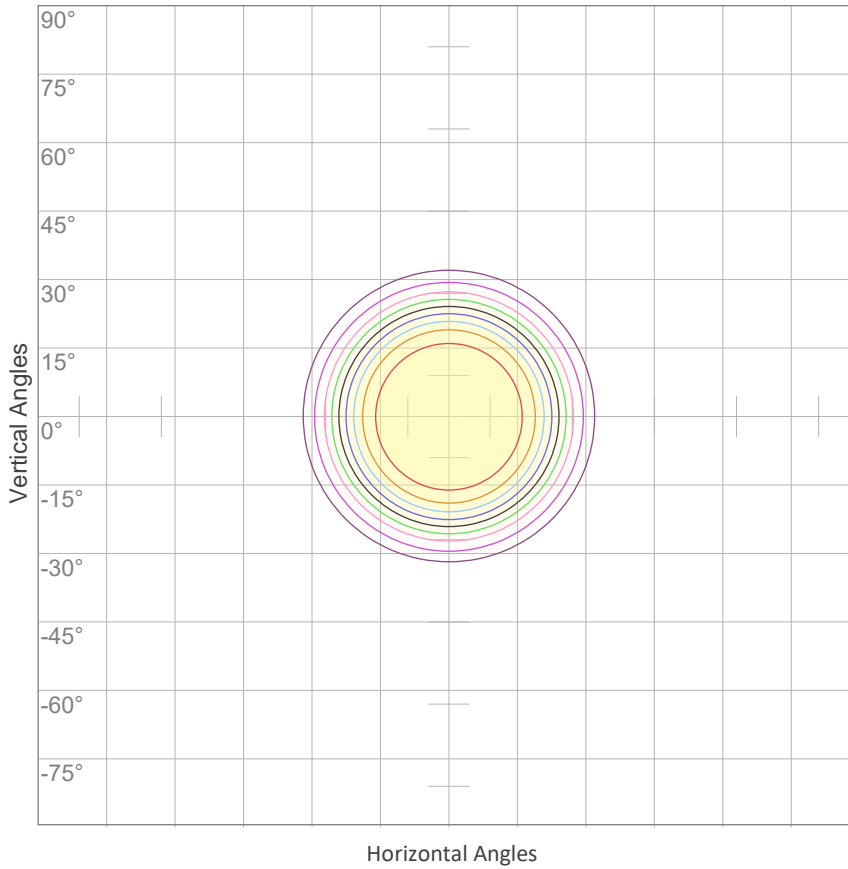

10%	2569 cd
20%	5139 cd
30%	7708 cd
40%	10277 cd
50%	12846 cd
60%	15416 cd
70%	17985 cd
80%	20554 cd
90%	23124 cd

Conditions:
 Number of c-planes: 2
 Candela at center: 25693 cd

ISO Lux Diagram

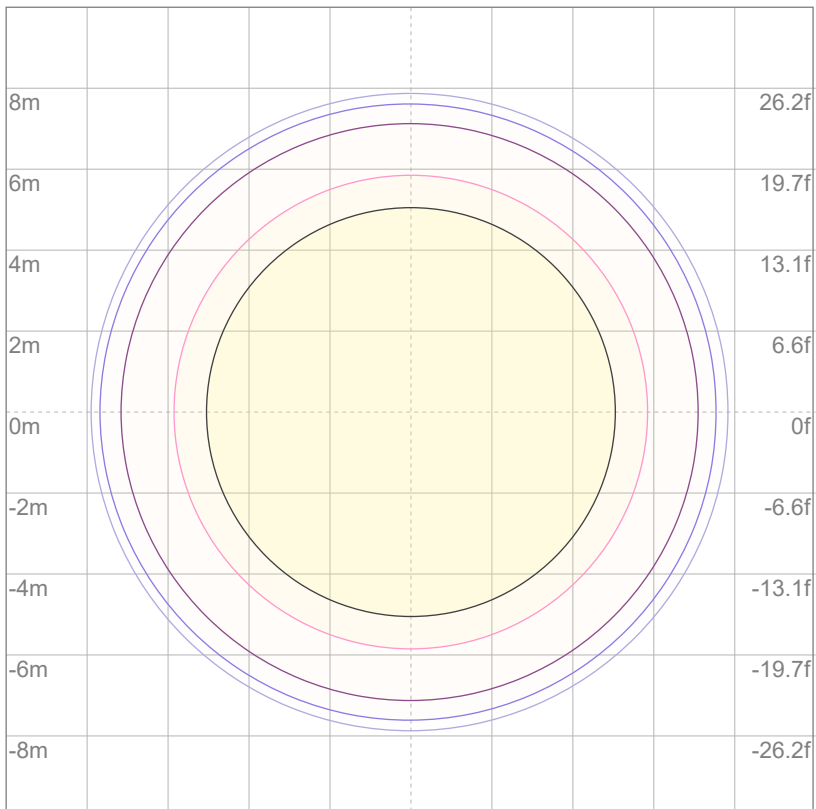

3%	7.71 lx
5%	12.8 lx
10%	25.7 lx
30%	77.1 lx
50%	128 lx

Conditions:
 Number of c-planes: 2
 Lux at center: 257 lx

Lux distribution on a surface when lamp is mounted at 10 meters from the surface.

Mounting Height: 10 meters (33 feet)

Photometric Report

Total Lumen Output*

VISO Lab Spion 9013 lm

Beam Angle 50%	Field Angle 10%	Cutoff Angle 2.5%
27°	31.7°	33.6°

Color Temperature: 5856 K

CRI: 80.5

TLCI: 73

TM30: 78.2

CQS: 83.0

Voltage: 116 V, Current: 5.97 A

Power: 690 W

Efficacy: 13 Lumen/Watt

Measurement Date: 9/20/2022

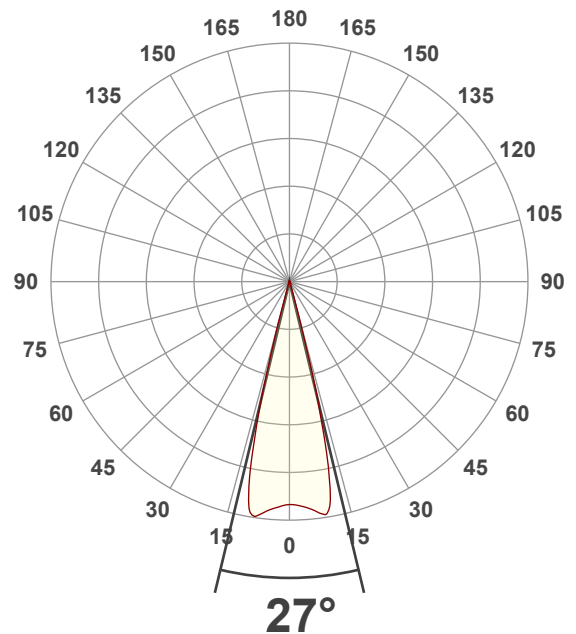

Spectral Distribution

Dominant Wavelength 605 nm

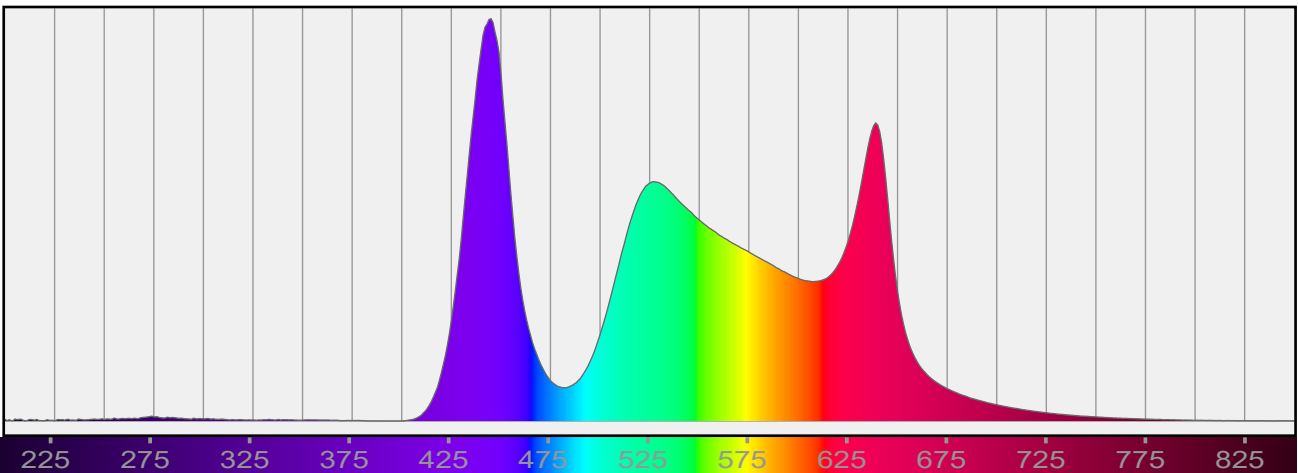

*Total Lumen measurements by calibrated Everfine 2π Integrating Sphere and Viso Systems Lab Spion

Beam Details

Beam Angle 50%	Field Angle 10%	Cutoff Angle 2,5%
27°	31.7°	33.6°

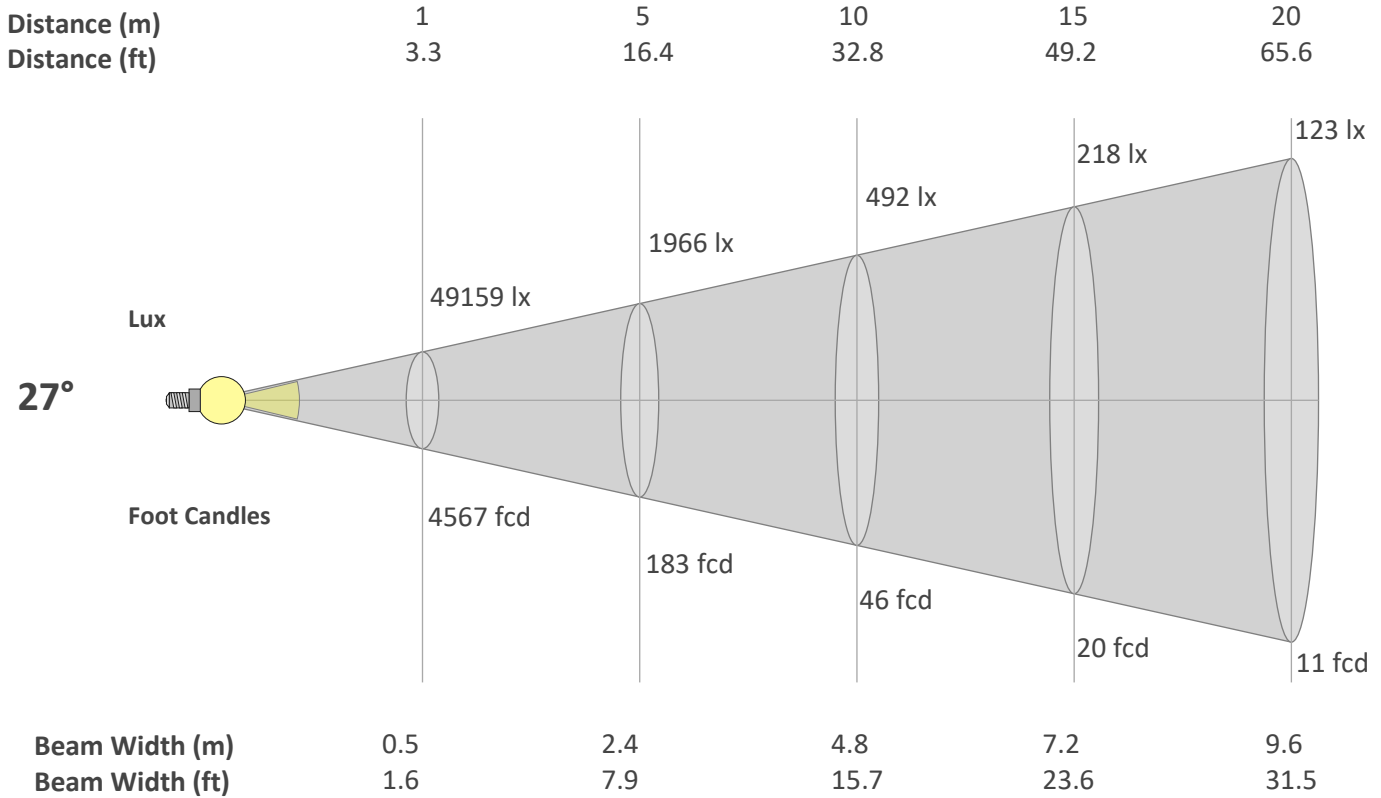

Beam Intensities from 1-20m

M	1	2	3	4	5	6	7	8	9	10	11	12	13	14	15	16	17	18	19	20
FT	3.3	6.6	9.8	13.1	16.4	19.7	23	26.2	29.5	32.8	36.1	39.4	42.7	45.9	49.2	52.5	55.8	59.1	62.3	65.6
LX	49159	12290	5462	3072	1966	1366	1003	768	607	492	406	341	291	251	218	192	170	152	136	123
FC	4567.1	1141.8	507.5	285.4	182.7	126.9	93.2	71.4	56.4	45.7	37.7	31.7	27	23.3	20.3	17.8	15.8	14.1	12.7	11.4

Linear Distribution

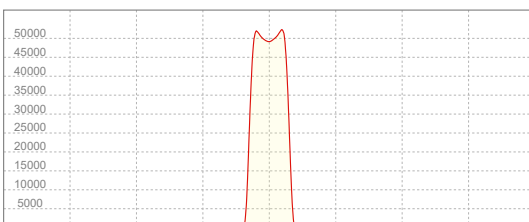

Peak Candela
52248 cd

Calculate Center Beam Intensities

$lux = 52248 / distance(m)^2$

$fc = 52248 / distance(ft)^2$

Color Details

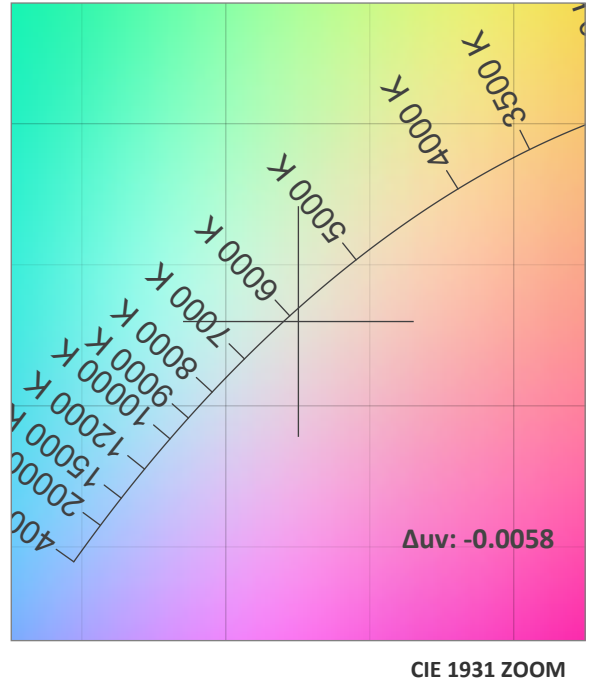
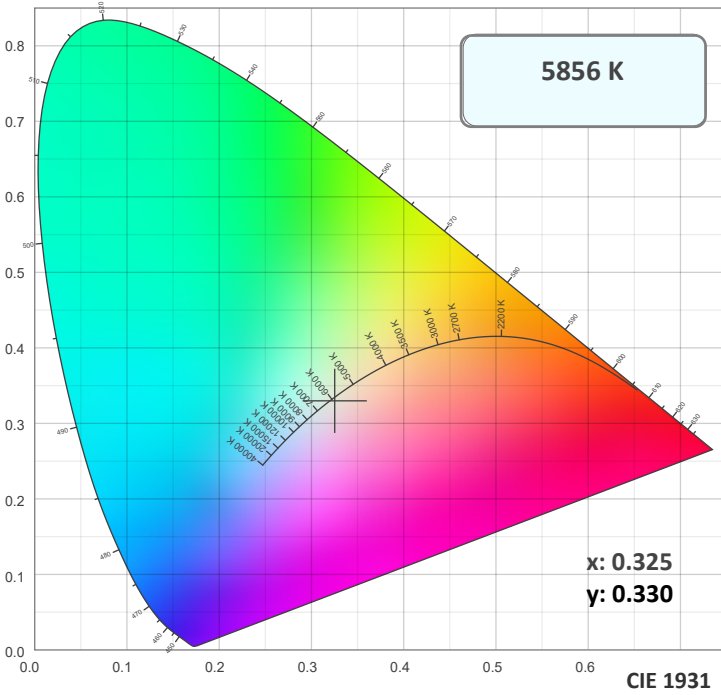

TM30: 78.2

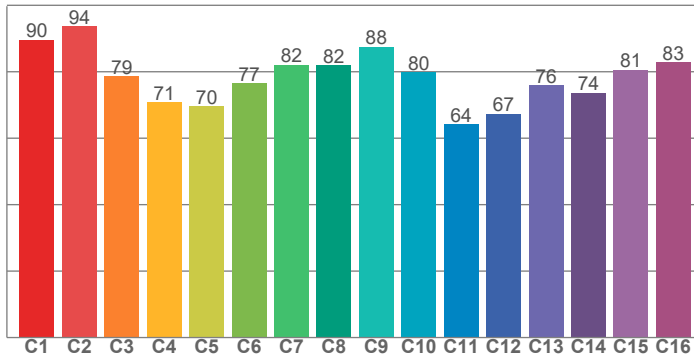

CRI: 80.5 (R1-R8)

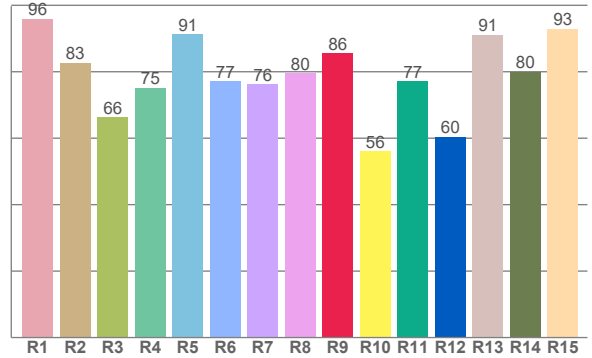

CRI R values, only R1-R8 are used to calculate final CRI value

R1	R2	R3	R4	R5	R6	R7	R8	R9	R10	R11	R12	R13	R14	R15
96.0	82.7	66.2	75.1	91.3	77.1	76.3	79.5	85.6	56.1	77.1	60.5	91.1	80.0	93.0

TM30 C Values, 16 binned values out of total of 99 C values

C1	C2	C3	C4	C5	C6	C7	C8	C9	C10	C11	C12	C13	C14	C15	C16
89.6	93.7	78.6	70.8	69.6	76.5	82.1	81.9	87.6	79.8	64.2	67.4	75.9	73.7	80.6	82.9

CQS Q Values

Q1	Q2	Q3	Q4	Q5	Q6	Q7	Q8	Q9	Q10	Q11	Q12	Q13	Q14	Q15
97.2	88.5	67.8	75.9	85.1	78.8	84.5	96.9	80.5	75.0	80.0	87.7	94.9	97.0	92.5

CQS: 83.0

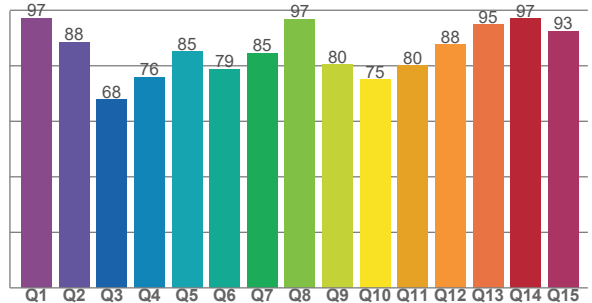

Color Parameters

Color Temperature	Color Rendering Index	Red Component	Color Fidelity	Color Gamut	Color Quality Scale	Color Coordinate CIE 1931	Color Coordinate CIE 1931	Color Coordinate	Color Coordinate	Color Diviation from Black
CCT	CRI	CRI R9	TM30 Rf	TM30 Rg	CQS	x	y	u	v	Δuv
5856 K	80.5	85.6	78.2	109.6	83.0	0.325	0.330	0.206	0.314	-0.0058

TM30 Details

Rf 78.2
Fidelity Index Rf

Rg 109.6
Gamut Index Rg

Hue Bin	R _f	Graphic shifts (%)	
		Chroma	Hue
1	90	1%	-5%
2	94	-2%	1%
3	79	0%	12%
4	71	6%	18%
5	70	14%	14%
6	77	17%	4%
7	82	11%	-6%
8	82	1%	-11%
9	88	-8%	-6%
10	80	-10%	7%
11	64	-5%	22%
12	67	2%	23%
13	76	11%	19%
14	74	14%	9%
15	81	19%	1%
16	83	8%	-7%

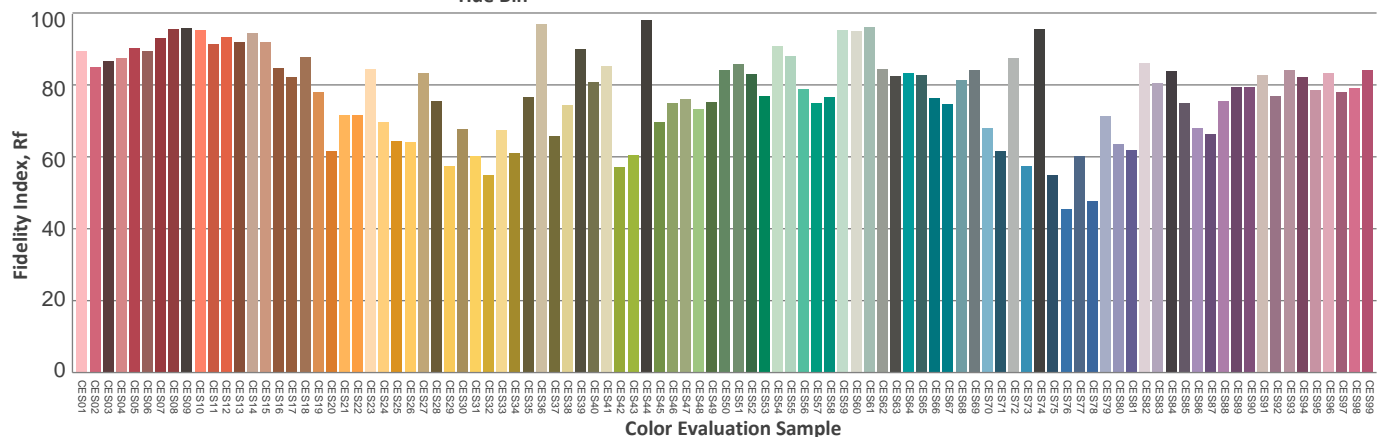
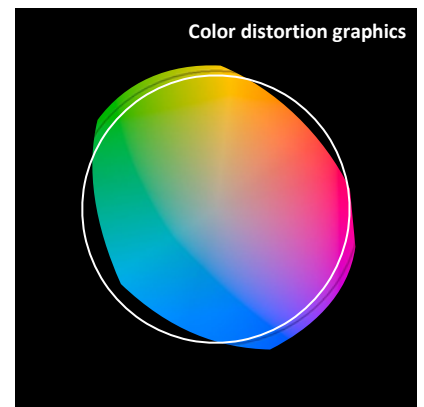
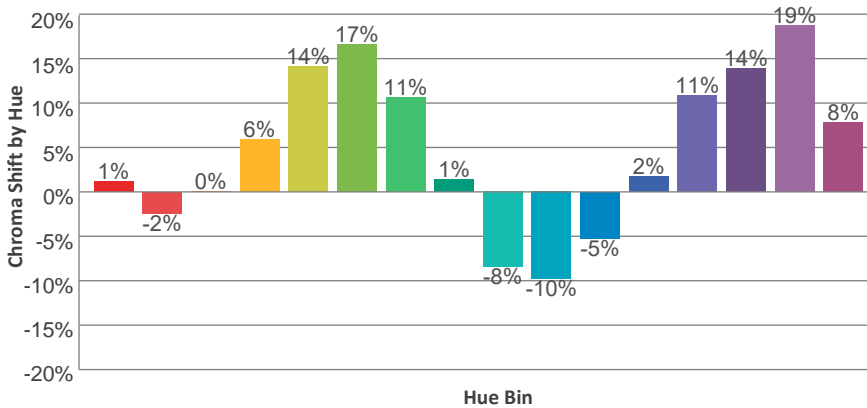
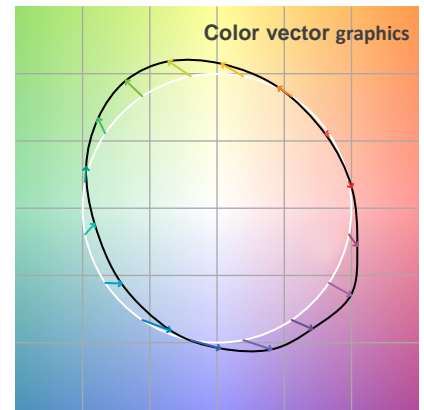
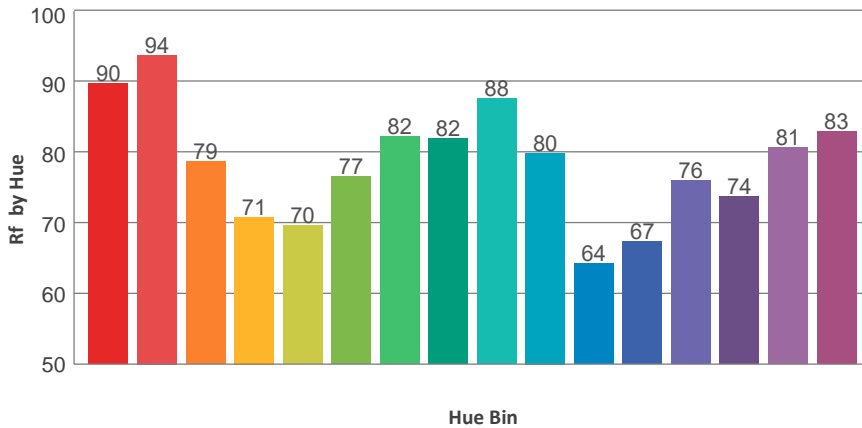
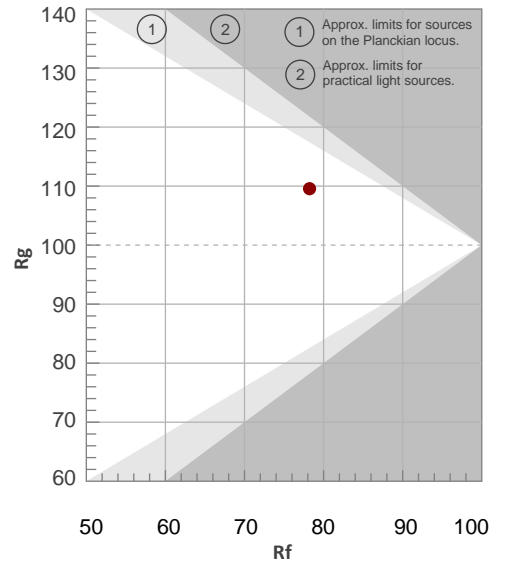

ISO Diagrams

ISO Candela Diagram

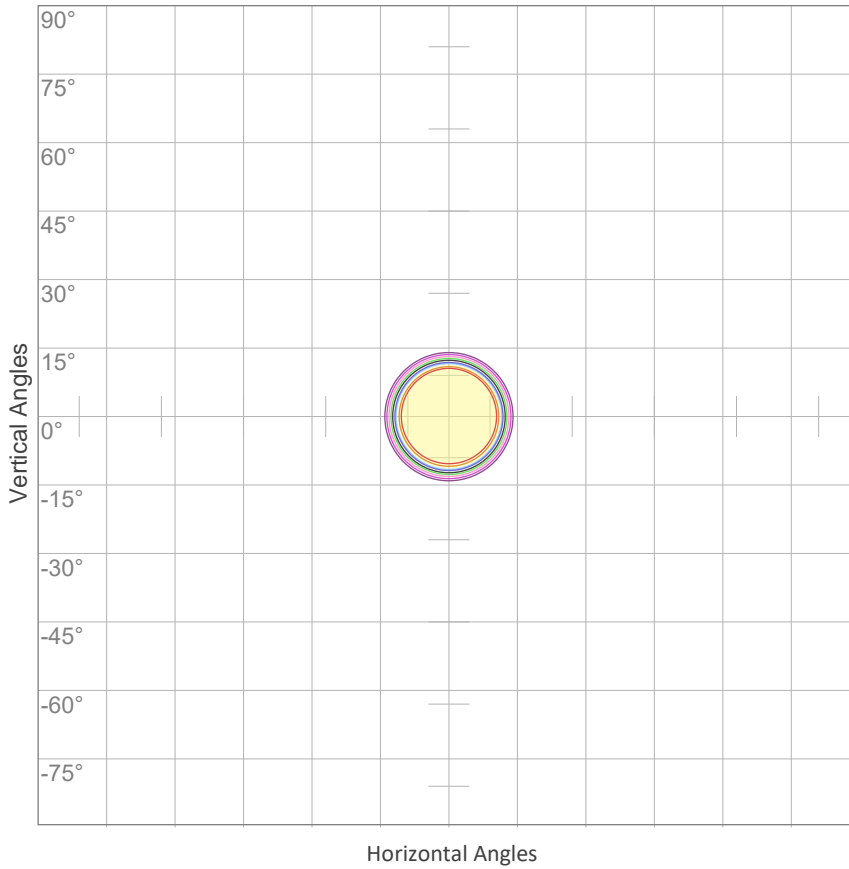

10%	4916 cd
20%	9832 cd
30%	14748 cd
40%	19664 cd
50%	24580 cd
60%	29496 cd
70%	34412 cd
80%	39328 cd
90%	44244 cd

Conditions:
 Number of c-planes: 2
 Candela at center: 49159 cd

ISO Lux Diagram

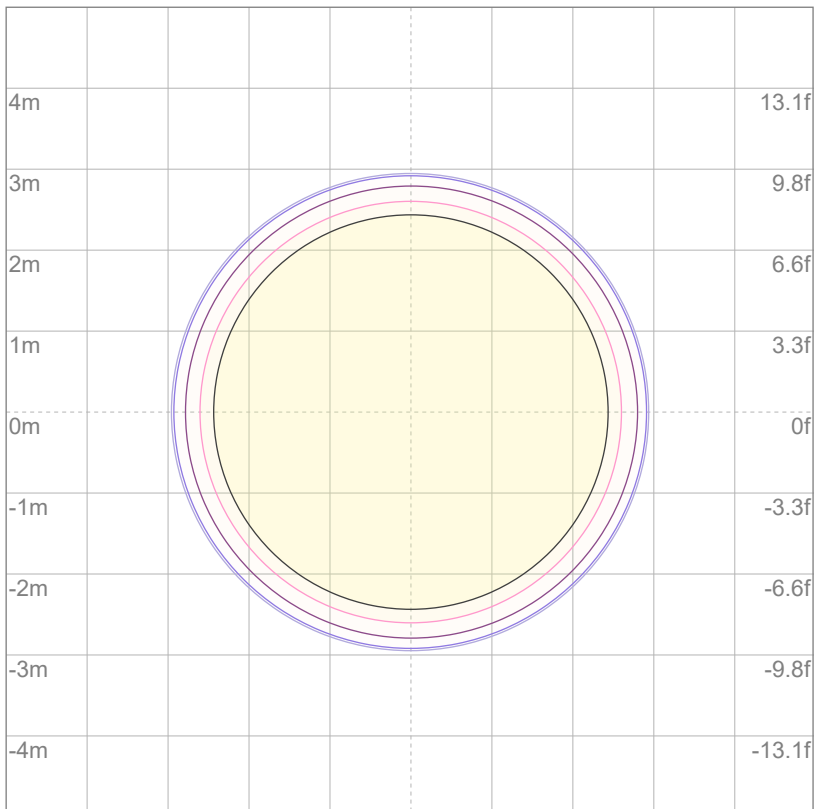

3%	14.7 lx
5%	24.6 lx
10%	49.2 lx
30%	147 lx
50%	246 lx

Conditions:
 Number of c-planes: 2
 Lux at center: 492 lx

Lux distribution on a surface when lamp is mounted at 10 meters from the surface.

Mounting Height: 10 meters (33 feet)